



## SERVICE MANUAL FOR CF 0.4 – 5 E (CO<sub>2</sub>) MODELS

(Evaporator Only)

380v – 415v 3 phase 50hz



## Table of Contents

<b>I. Overview .....</b>	<b>4</b>
<b>II. Operation Conditions &amp; Performance Parameters</b>	
1. Conditions for Operation.....	4
2. Diagram of Ice Output of Ice Machines.....	4
3. Dimensions.....	6
4. Specifications.....	7
<b>III. Packing, Transportation, Storage &amp; Installation</b>	
1. Transportation and Handling.....	7
2. Installation.....	7
3. Pipe Connection Diagram .....	8
<b>IV. Operating Procedures .....</b>	<b>9</b>
<b>V. Operating Principles</b>	
1. Refrigeration System.....	11
2. Water Circulation System.....	11
3. Ice Level Control Assembly.....	12
4. The Gear Box .....	12
5. P.C. Board Control System .....	12
<b>VI. Safety Precautions.....</b>	<b>13</b>
<b>VII. Cleaning Procedures .....</b>	<b>14</b>
<b>VIII. Trouble-Shooting.....</b>	<b>15</b>
<b>IX. Wiring Diagram.....</b>	<b>16</b>
Wiring Diagram with Timer.....	17
<b>X.PC Board Explained .....</b>	<b>18</b>
1. Circuit Board Layout .....	18
a) Ice making machine PC Board layout (back).....	18
b) ice making external indicator small board layout.....	18
c) Ice full sensor sensitivity small board layout .....	19

2. Fault Indicator .....	19
3. Dip Switch.....	20
a) 8-bit DIP Switch .....	20
b) 4-bit DIP Switch.....	21
4. Electrical Wiring Diagram.....	22
a) Ice machine PC Board wiring diagram .....	22
b) Ice Machine external indicator (small board) wiring diagram.....	22
c) Ice Making sensor wiring diagram .....	23
5. Ice Full Sensor sensitivity and DIP switch settings .....	24
a) Full sensor sensitivity settings .....	24
b) Ice Full sensor sensitivity and adjustment method .....	24
c) DIP Switch settings method.....	24
<b>XI. Timer Switch.....</b>	<b>25</b>
<b>XII. Technical Notes .....</b>	<b>35</b>
<b>XIII. Service Bulletins.....</b>	<b>36</b>

## I. Overview

**Read this service manual carefully before installation and operation of this ice machine.**

This Service Manual gives an introduction of operating conditions, performance parameters, installation and troubleshooting procedures of the CF series ice machine (CO<sub>2</sub> as refrigerant). The ice making system has a vertical, static evaporator with a rotating auger. The machine is equipped with a P.C. board, which controls and monitors the functionality, indicating:

- (1) Ice level
- (2) Water level in water tank
- (3) Motor and gearbox operation
- (4) Temperature of Evaporator

## II. Operation Conditions & Performance Parameters

### 1. Conditions for Operation

	Minimum Conditions	Operating	Maximum Operating Conditions
Ambient Temperature	5°C		40°C
Water Temperature	5°C		40°C
Water Pressure	0.15MPa		0.5MPa
Deviation from Voltage Rating	-10%		+10%

### 2. Diagram for Ice Output of Ice Machine

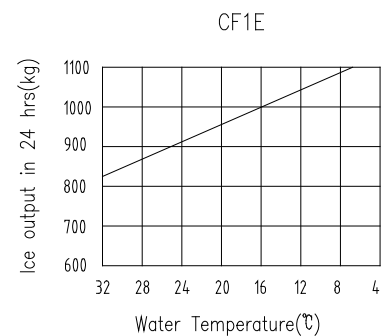
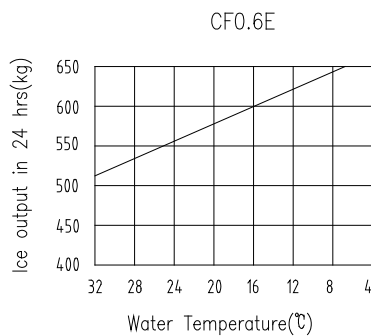
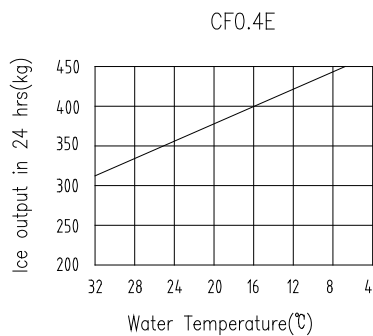

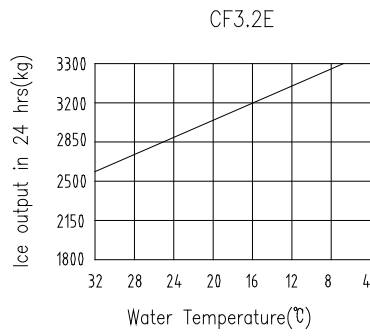
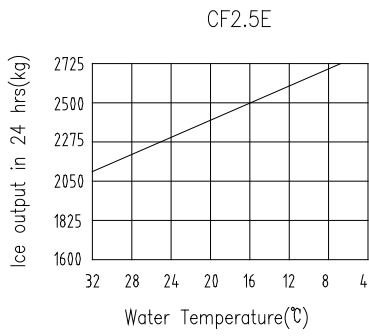
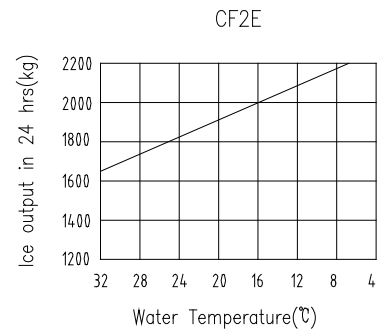
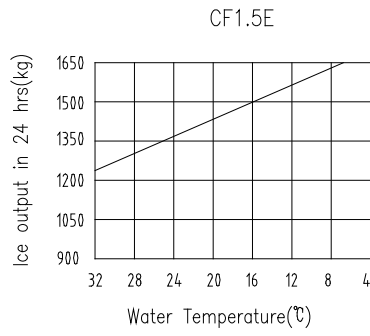
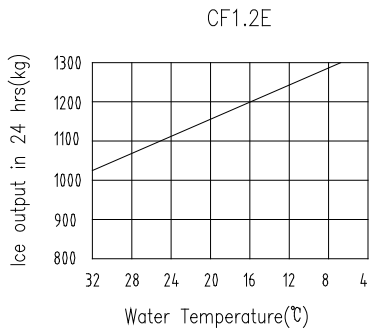

**The parameters are subject to change without notice.**

3. Dimensions (see figure 1)

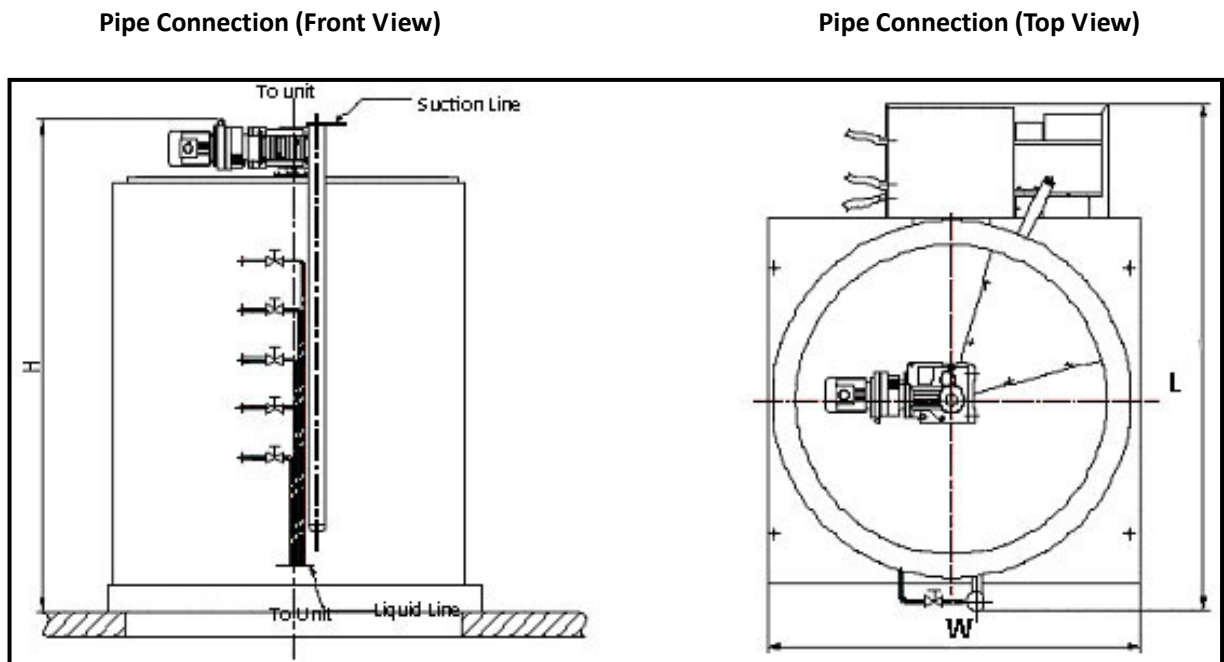

Type	Standard Ice Output 1000kg /24h	Dimension mm (L×W×H)	Gear Box Motor Power (W)	Water Pump Motor Power (W)	Water Consumption l/h	Refrigeration Power (kW)	Inflow Tube OD Φ(mm)	Air Suction Tube OD Φ(mm)	Weight (t) kg	Water Inlet Pipe (female threaded)	Water overflow Pipe (OD)
CF0.4E	0.4	1090*700*720	120	10	17	2.2	20	25	170	¾"	Φ21
CF0.6E	0.6	1250*750*820	120	10	25	3.3	20	30	160	¾"	Φ21
CF1E	1	1050*850*870	180	10	42	5.5	12.7	22	170	¾"	Φ21
CF1.2E	1.2	1050*850*880	180	10	50	6.6	12.7	22	180	¾"	Φ21
CF1.5E	1.5	1050*850*1050	180	10	63	8.5	12.7	28	200	¾"	Φ21
CF2E	2	1050*850*1080	180	20	83	11.0	12.7	28	230	¾"	Φ21
CF2.4E	2.4	1050*850*1250	180	20	100	13.5	12.7	28	240	¾"	Φ21
CF3.2E	3	1050*850*1300	180	20	125	16.5	12.7	28	280	¾"	Φ21

4. Specifications

- Notes:
1. Standard operating conditions: Ambient temperature 25° air and water temperature 16°.
  2. The evaporator temperature shall be -22° and condenser temperature + 45° (air-cooled) or 40° (water-cooled).
  3. Power supply: 415V/50HZ/3N
  4. Refrigerant: CO<sub>2</sub>
  5. Supply water pressure: 0.15-0.5MPa

### **III. Packing/ Transportation/ Storing and Installation**

1. **Packing, Transportation and Storing** The ice machine is packed in plywood.  
Beware of collision, vibration, tilting, inversion, etc. in transportation and storage. Ice machine should be kept below 40C, dry, and well-ventilated

**Before you begin:**

- A. Check your paperwork to determine the model received matches your order.
- B. After uncrating and removing all packing material, inspect equipment for any shipping damage.
- C. Check whether all connections (water system, refrigerant system, etc.), electrical connections (wires, PC board, etc.) and mechanical system are in good condition.

**2. Installation**

- A. Electrical connections must comply with local standards and requirements on the rating plate of the machine.
- B. An isolation switch must be installed
- C. Constant water supply (Pressure between 0.15 kPa to 0.5 MPa) and stop cock shall be supplied within 1 mtr of the ice machine. Suitable drainage point shall be within 1 mtr of ice machine. Two separate water drainage lines shall be required for draining the ice machine and the ice storage bin.
- D. The ice machine shall not be placed (1) without suitable ventilation; (2) next to heat sources; or (3) outdoors.
- E. To ensure ice quality a water filter should be installed in icemaker inlet water line.

### 3. Pipe connection Diagram and Machine dimensions and Ice Outlet Dimensions

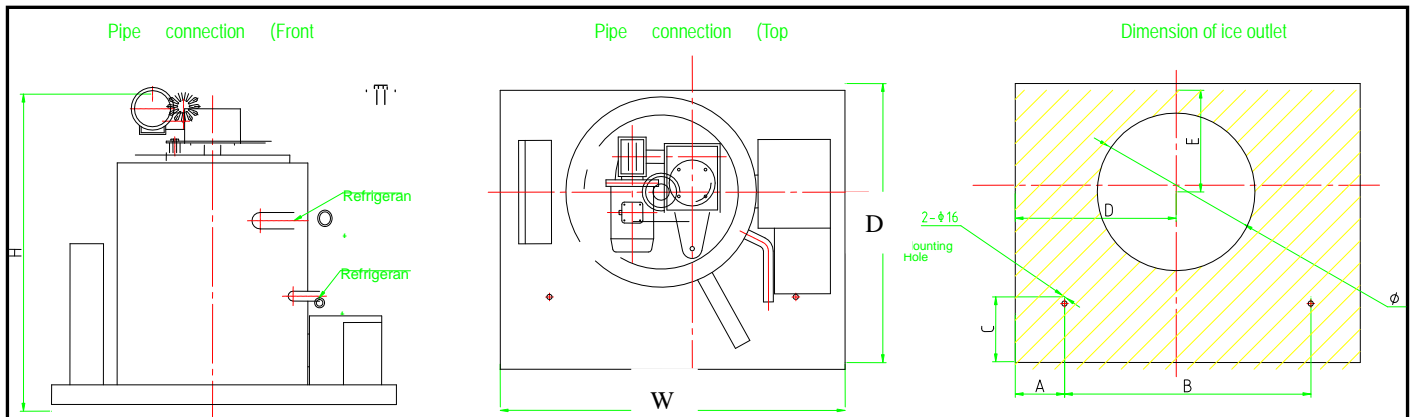

Figure 3

Type	A	B	C	D	E	D	W	H	Φ
CF0.4E	87	395	658	447	216	1050	850	870	326
CF0.6E	95	450	665	430	419	1250	750	820	326
CF1E	150	750	198	490	310	1050	850	870	480
CF1.2E	150	750	198	490	310	1050	850	880	480
CF1.5E	150	750	198	490	310	1050	850	1050	480
CF2E	150	750	198	490	310	1050	850	1080	480
CF2.4E	150	750	198	490	310	1050	850	1250	480
CF3.2E	150	750	198	490	310	1050	850	1300	480



#### IV. Operating Procedures

##### 1. Before start up check the following:

- 1) Power connections are safe, reliable and complies with local standards and requirements on the rating plate on the machine
- 2) Water pressure is within the specified range of 0.15-0.5MPa.
- 3) The earth wire is securely connected.
- 4) All fastening bolts have been tightened.

##### 2. Start

- 1) Open water supply valve to fill up the water tank, the float valve will automatically close when water reaches the desired level.
- 2) During testing turn on the circuit breaker, Turn Manual "Off/Auto" button on the electrical cabinet to Start position, enabling the ice-maker to enter a 5-minute-delay state (Start Delay indicator light blinks) which is followed by the automatic start of gear box and water pump (1) Check that the ice blade is rotating in the right direction (2) water level in distributor pan is aligned with the red mark and water flow is adequate. If operation is normal then switch Stop / Start switch to Stop.
- 3) Ice production stage: Switch the Start/Stop button of ice machine to Start, which enables the ice machine to start ice production after a 5-minute delay. Start refrigeration system and open suction and liquid line valves. When refrigeration system reaches an evaporator temperature of -20c, Ice will be produced.

##### 3. Stop

When the Manual "Off/Auto" button is switched off, water pump and liquid line solenoid valve stop working immediately, and the gear box stops working after a 3-minute delay so as to remove ice left on the interior of the evaporator cylinder.

##### 4. Failure due to alarm

- 1) Unit stopped due to ice full level alarm (normal stop):

When PC board detects full level of ice in storage bin, Water pump and solenoid valve are stopped first, and then the gear box motor stops after a 3-minute delay and ice full level indicator turns on at the same time. Now the system is in stand-by mode. After the ice is removed from bin full sensor, the system will return to normal operating status: gear box motor, water pump and solenoid valve will be started in sequence.

- 2) Failure due to low water level alarm:

When PC board detects low water level in the storage tank: water pump and solenoid valves stop first, and then gear box motor stops after a 1-minute delay and low water level indicator turns on at the same time. Now the system is in stand-by mode. After the water tank is refilled, the system automatically returns to normal operating status: gear box motor, water pump and solenoid valve will be started in sequence.

- 3) Failure due to low speed of gear box motor (Fault Light ON)

When PC board sensor detects suspension, reversal or low speed of gear box motor, Gear box motor, water pump and solenoid valve stop and give alarms simultaneously. Fault will need to be diagnosed, eliminated and PC fault reset for system to return to service.

4) High evaporator temperature alarm (Fault Light FLASHING)

After 10-minutes of operation, PC board begins temperature detection program: when evaporator temperature exceeds a set point, the microprocessor implements a Hi-temp fault program: water pump and solenoid valve stop immediately and gear box stops after a 6-minute delay and gives alarm signal simultaneously. The fault will need to be diagnosed, rectified and fault reset for system to return to service.

**Other notes: This machine does not indicate condenser temp.**

**A. Electric box Panel Diagram 5:**

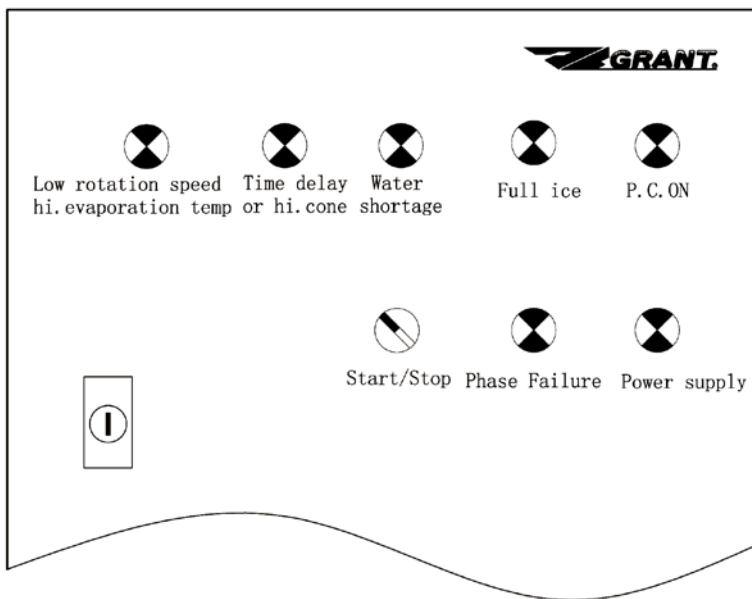

Figure 5



Manual Off/Auto switch install on ITS

**B. Manual “Off/Auto” Switch**

- a. Starts or Stops the machine.
- b. Restarts the machine after a fault has been rectified.

**C. “DIP” Switch:** P.C. board is equipped with 8 “DIP” switches, which do not need to be adjusted in normal operation, all switches are set to OFF position except No.2, No.3 and No.6 switch to ON position, as shown in Figure 6 below.

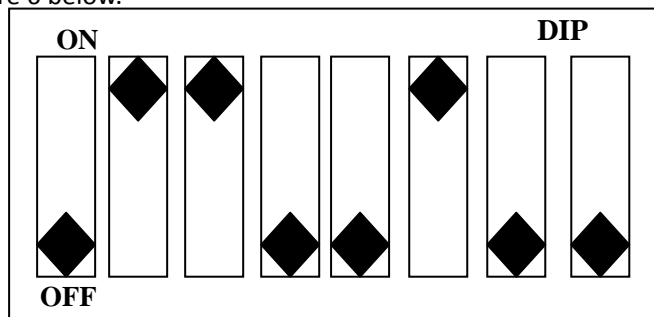

Figure 6

No.1 Switch: When the switch is set to ON position, the machine will be started without a 5-minute delay; when it is set to OFF position, the machine will be started with a 5-minute delay. The switch is set to OFF position at factory. No.2 & No.3 switches: are in ON position for sub zero ice production. No.6 switch: Alarm buzzer, factory set in On position.

## V. Operating Principles

### 1. Refrigeration System (See Figure7)

When liquid refrigerant flows through evaporator cylinder, the refrigerant lowers the temperature of the evaporator cylinder through heat exchange, meanwhile water in contact with the evaporator surface freezes, and ice detaches from the surface from the action of the ice blade rotation and falls into ice storage bin.

### 2. Water Circulation System (See Figure7)

Supply water flows into the water tank via the float valve. Water is pumped into the distributor pan and then flows to the evaporator's interior surface. The cooling process occurs gradually and part of the water turns into ice. The ice is detached from the interior by the rotating blade and falls into the ice storage bin.

#### Note:

- 1) Feed water level is monitored by a sensor. In case water tank runs out of water or has soft water (demineralized), P.C. board stops the operation of the machine and the yellow LED turns on to indicate low water level alarm. The machine will reset to normal operation after water level recovers.
- 2) When being tested at the factory, the water level in water distributor pan has been set in line with the red mark on the water level indicating bolt, If the water level is not in line with the red mark, the specified water level can be achieved through adjusting the valve in water tank or the valve fixed on the top of evaporator (with the depth of water in the pan being 26mm for 10-ton and smaller ice machine, 38mm for 15-ton and bigger ice machine).

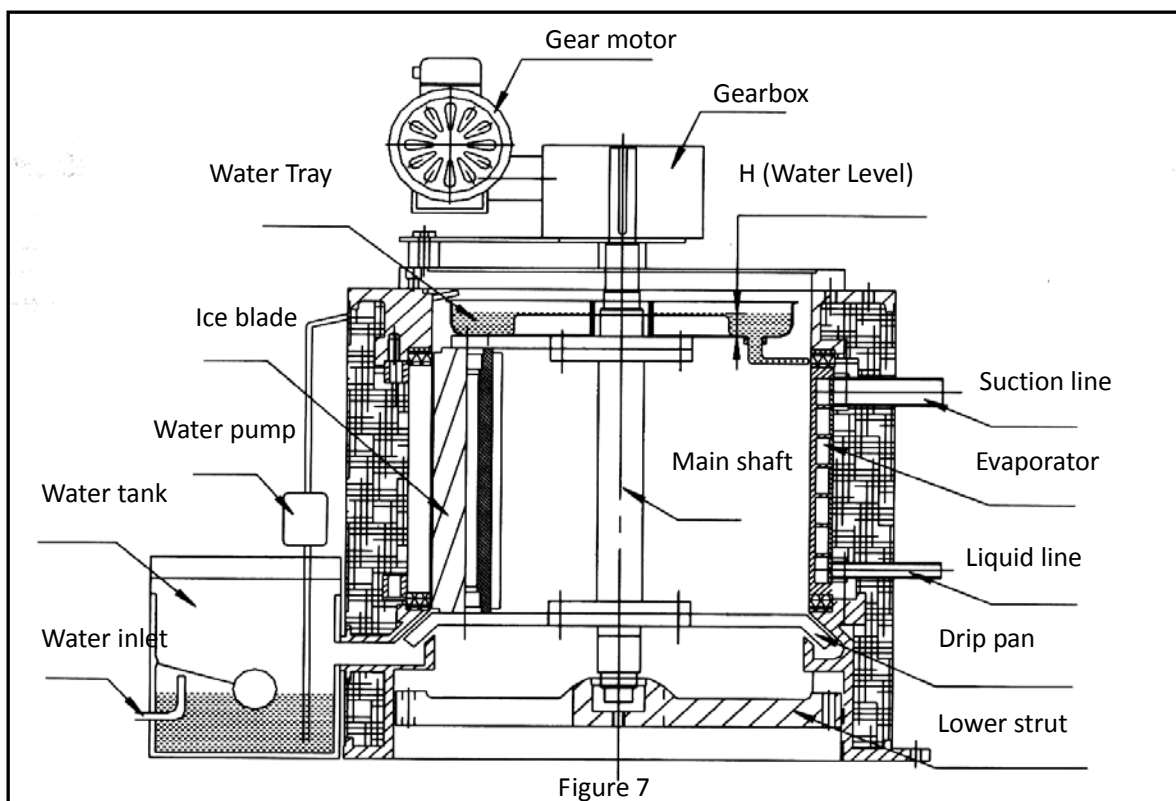

### 3. Ice Level Control.

Between ice machine and ice storage tank there is an optical ice level control sensor. When the ice reaches the sensor and blocks the optical beam, the red LED at the center of the P.C. board goes out immediately. After the light beam has been blocked for a given time, production of ice stops and the yellow LED turns on to indicate ice full state. When ice is removed from the sensor, the light beam resumes and the red LED on the P.C. board lights immediately. Ice machine restarts in 10 seconds and ice full, yellow LED goes out.

### 4. Gear box system

This system consists of gearbox motor and gearbox. The former drives the latter, and the gearbox output shaft propels the rotating ice blade and water distributor pan. When gearbox motor runs in the wrong direction or its speed is less than 1300rpm, a signal is sent by the sensor to the P.C. board, which stops the operation of ice machine. The cause of fault must be identified and the fault eliminated before ice machine will restart. Press the Reset button on the P.C. board once or turn the Start/Stop button to reset the unit.

### 5. P.C. Board Control System (See Figure 8)

THE P.C. Board controls the entire process of ice machine operation based on the signals transmitted by different sensors.

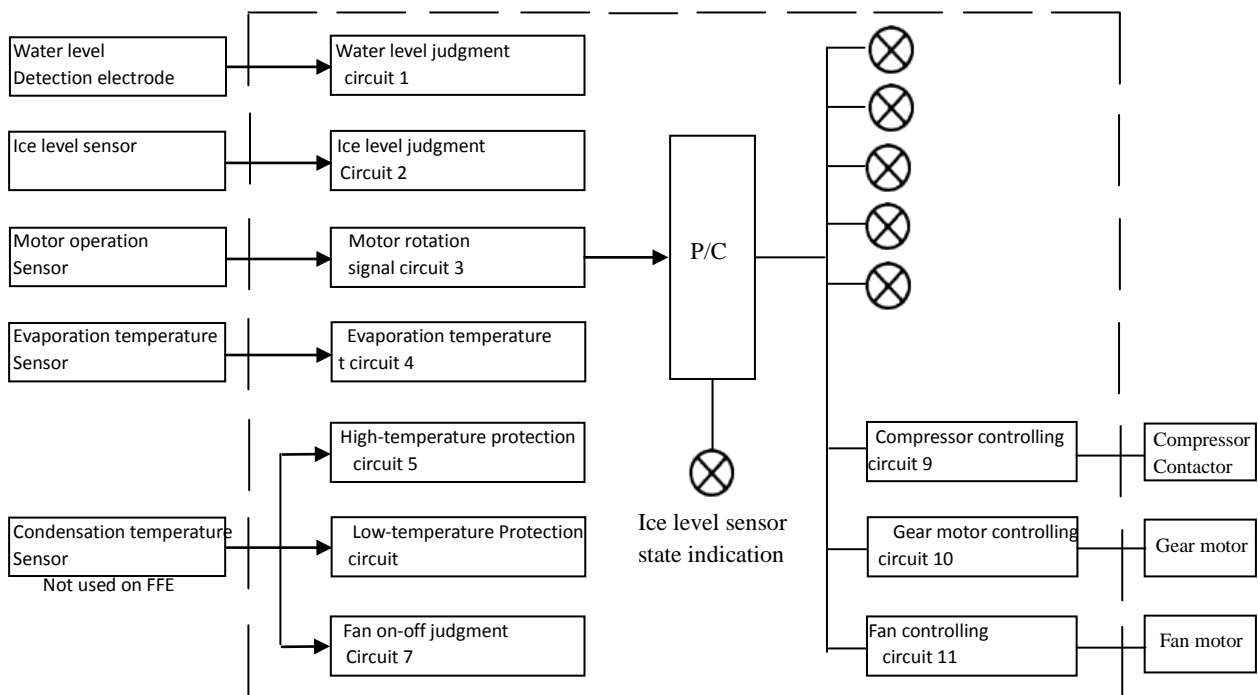

Figure 8

## **VI. Safety Precautions:**



**Warning:** Main power supply must be cut before conducting any operation for cleaning and maintenance, Especially when the ice-machine is in the “bin full” and “no water” states. In this case, **DO NOT** do any maintenance or repair of the ice-machine (especially the inner part of the machine), Ice-machine may automatically start at any time.

**Special care for the following safety precautions shall be taken into account during commissioning, normal operation and maintenance of ice machine.**

- 1) No repair or maintenance shall be carried out before ice machine has been confirmed not in operation and disconnected from main power supply.
- 2) With ice machine in operation or energized, no body part or other object shall be allowed to enter the evaporator barrel.
- 3) After a power loss or outage, Take care to check rotation of gearbox
- 4) During installation, commissioning and operation be sure not to allow body to contact discharge pipes.
- 5) All refrigerant pipe work needs to be inspected and fully pressure tested before commissioning.
- 6) All state and local guide lines and standards must be adhered to.

## VII. Cleaning Procedures



**Warning:** No cleaning or maintenance shall be carried out on the machine prior, to carrying out correct isolation procedures to isolate the machine from the power and water supply. Coast Distributors recommends the use of PPE when carrying out a service or maintenance on either the ITS, BIN, or Grant ice machine.

1. Carry out correct isolation procedures and test unit for power loss.
2. Isolate the water supply to the machine.
3. Remove and replace the water filter cartridge and purge approx 4ltrs of water through filter.
4. Carry out visual inspection of the unit.
5. Remove the black top plastic cover on the evaporator.
6. Check condition of water distributor and tubes.
7. Check condition of plastic water pan at the bottom of evaporator.
8. Check water float operation and water level. Adjust or replace if required.
9. Check water trough for foreign matter and clear if required.
10. Check water reservoir.
11. Check for any water leaks.
12. Isolate the refrigeration circuit, so as no refrigeration of the evaporator occurs this can be done by either separating the compressor overload from the contactor ( all AR models )or isolating the power to the liquid line solenoid valve coil on (all FFE models)
13. Drain the water from the water reservoir via the drain tap on rear of tank and measure water quantity. This is to ascertain how much cleaning solution is required.
14. Make up correct amount of cleaning solution as per manufacturer's directions and empty solution into the water reservoir.
15. Re-energize the power to the machine and set dip switch 1of 8 (time delay override) to the up position and turn the machine on.
16. Run the machine for the correct indicated time as per chemical manufactures directions (usually 20 min). During this time the machine will fault on high evaporator temp alarm (10 min delay) and will require a reset to start the alarm delay over again.
17. Once the cleaning time has elapsed, turn unit off and drain the water and flush the system 4 times.
18. Clean the bin and flush / check the drain.
19. Drain the water from the water reservoir via rear drain tap.
20. Mix up and add sanitizer solution to the system, turn unit back on.
21. Sanitize bin.
22. Follow the manufactures directions on the sanitization procedure.
23. After 10 min reset and wait another 10 min. Once this time has elapsed, turn the unit off and drain the water and flush the system 4 times.
24. Carry out correct isolation procedure and test unit for power loss.
25. Re-connect the compressor overload or solenoid valve coil power.
26. Reset the delay timer dip switch (no 1 of 8) back to the off position "Down".
27. Clean the unit, condenser and covers where fitted.
28. Turn the water back on to the machine.
29. Re-energize the power and turn the machine on.
30. Check operation of unit.
31. Check Auto/Off/Man operation and time clock setting.
32. Check bin legs, door and trolleys where applicable.

The above procedure takes approx 1.5 to 2 hrs depending on, if is on a slope front bin or a Follett ITS.

**VIII. Trouble-shooting**

Fault Description	Possible Causes	Recommendations
Machine inactive  (1) PC board Power indicator not on  (2) Ice full level indicator on  (3) Low water level indicator on  (4) Evaporator temp indicator ( flashing )  (5) Low rotation speed indicator ( on )	Main switch is set to OFF position  P.C. board's fuse blown (750mA)  Malfunction of P.C board  Connection wire loose Malfunction of ice level control assy.  Low water level or water too soft  Evaporator temp. sensor damaged Low gas charge High ambient temp  Gear box motor's rotation reversed  Gear box motor's spinning speed is too low	Selector switch needs to be set to ON position Replace the fuse and diagnose the cause of fuse fault Replace the P.C.Board  Check the wiring Clean or replace ice level control assembly Please refer to recommendations for low water level alarm  Replace Check/ leak test and repair  Check motor wiring and capacitor/ phase rotation  Check motor bearing, evaporator cylinder bearings, TX adjustment
Compressor runs intermittently	Voltage is too low Non condensables Loose compressor contact terminals	Check supply power and wiring Eliminate the fault Check and tighten all wiring
Low ice production	Expansion valve partially blocked or not adjusted properly Moisture in the system Low water level in distributor pan Low refrigerant charge	Adjust TX valve  Reclaim gas, evacuate and charge Adjust it to the specified water level Check for leaks and charge
Ice machine in operation but no ice is being produced	No water in water cylinder for ice production Gear box not rotating	Check water pump , flow valve and pipe work Check, repair or replace it
Water leak	Water level is too high in water tank Water level is too high in distributor pan	Adjust Adjust
Noisy gearbox	Motor's bearings worn out Gear box low in lubrication oil Gear box's bearing and gears worn	Check or replace it Check gear box and add lube oil Check and replace the worn parts
Low water level	Feed water pipe blocked	Dismantle and clean the pipe

### X.Wiring Diagram

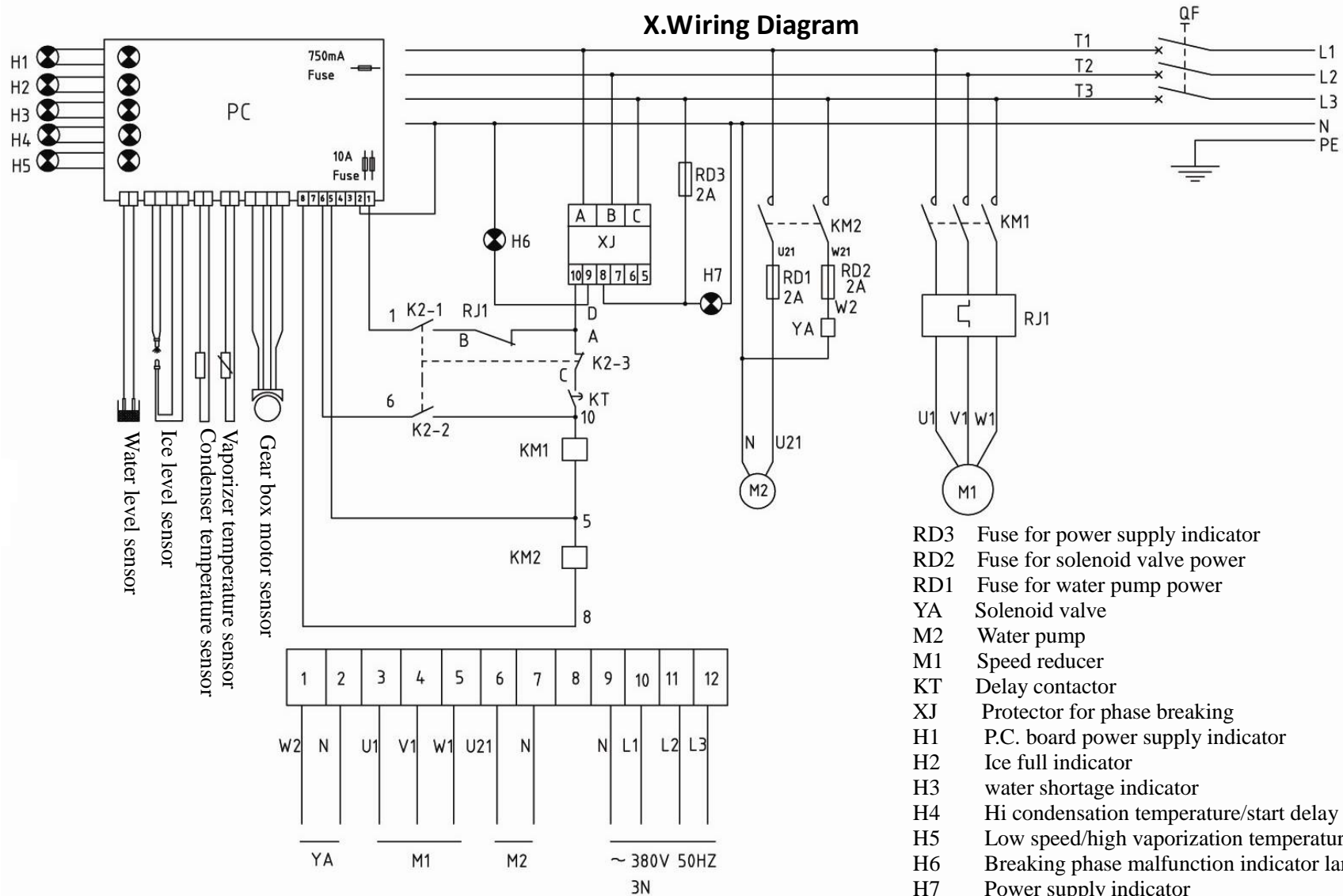

- RD3 Fuse for power supply indicator
- RD2 Fuse for solenoid valve power
- RD1 Fuse for water pump power
- YA Solenoid valve
- M2 Water pump
- M1 Speed reducer
- KT Delay contactor
- XJ Protector for phase breaking
- H1 P.C. board power supply indicator
- H2 Ice full indicator
- H3 water shortage indicator
- H4 Hi condensation temperature/start delay indicator
- H5 Low speed/high vaporization temperature indicator
- H6 Breaking phase malfunction indicator lamp
- H7 Power supply indicator
- RJ1 Thermal overload protector for speed reducer
- KM2 AC contactor of water pump
- KM1 AC contactor of speed reducer
- K2 P.C. board switch
- QF Air switch

Notes: This machine does not use condenser temperature sensor



IX. Wiring Diagram with timer

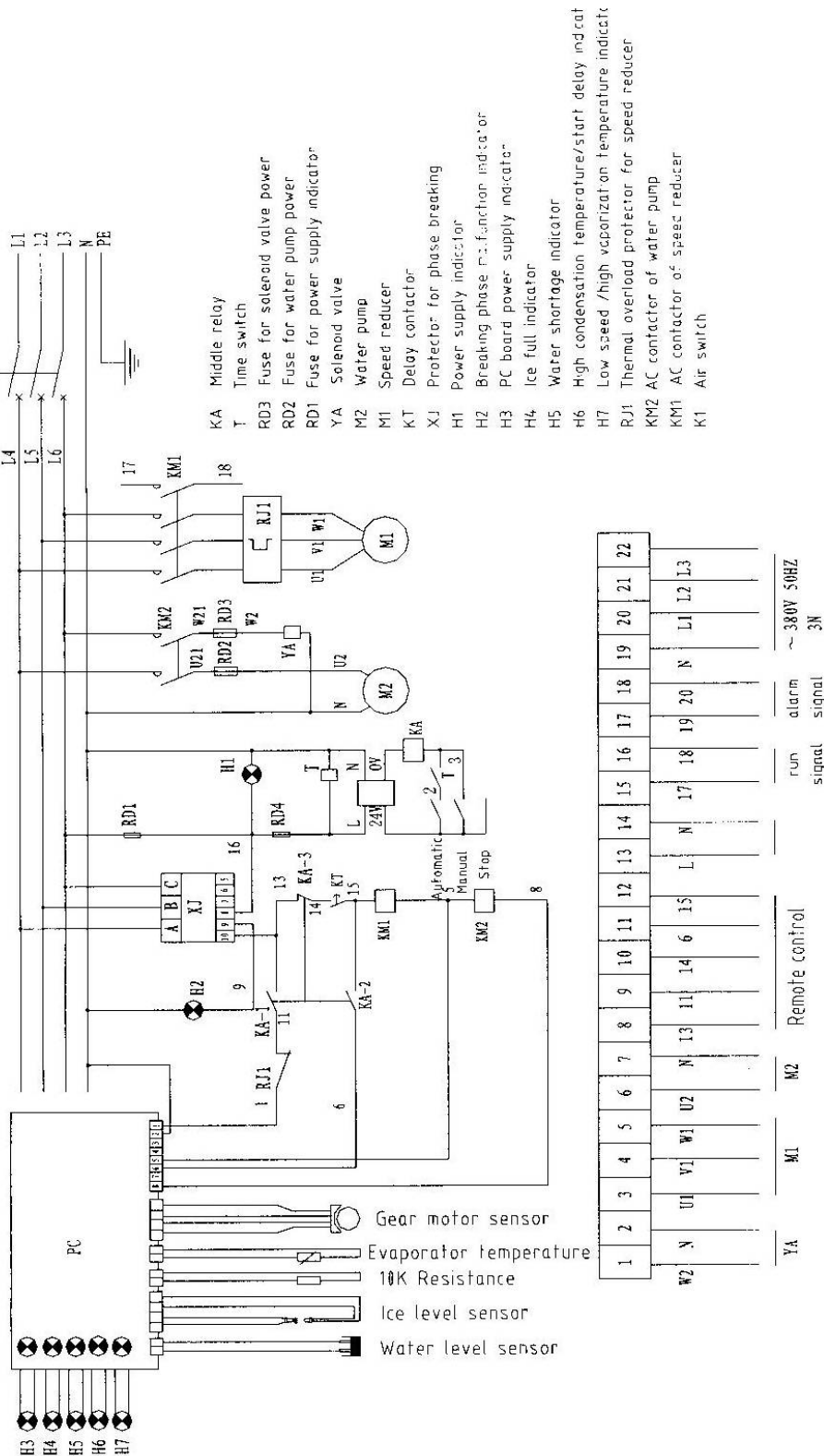

X. PC BOARD EXPLAINED



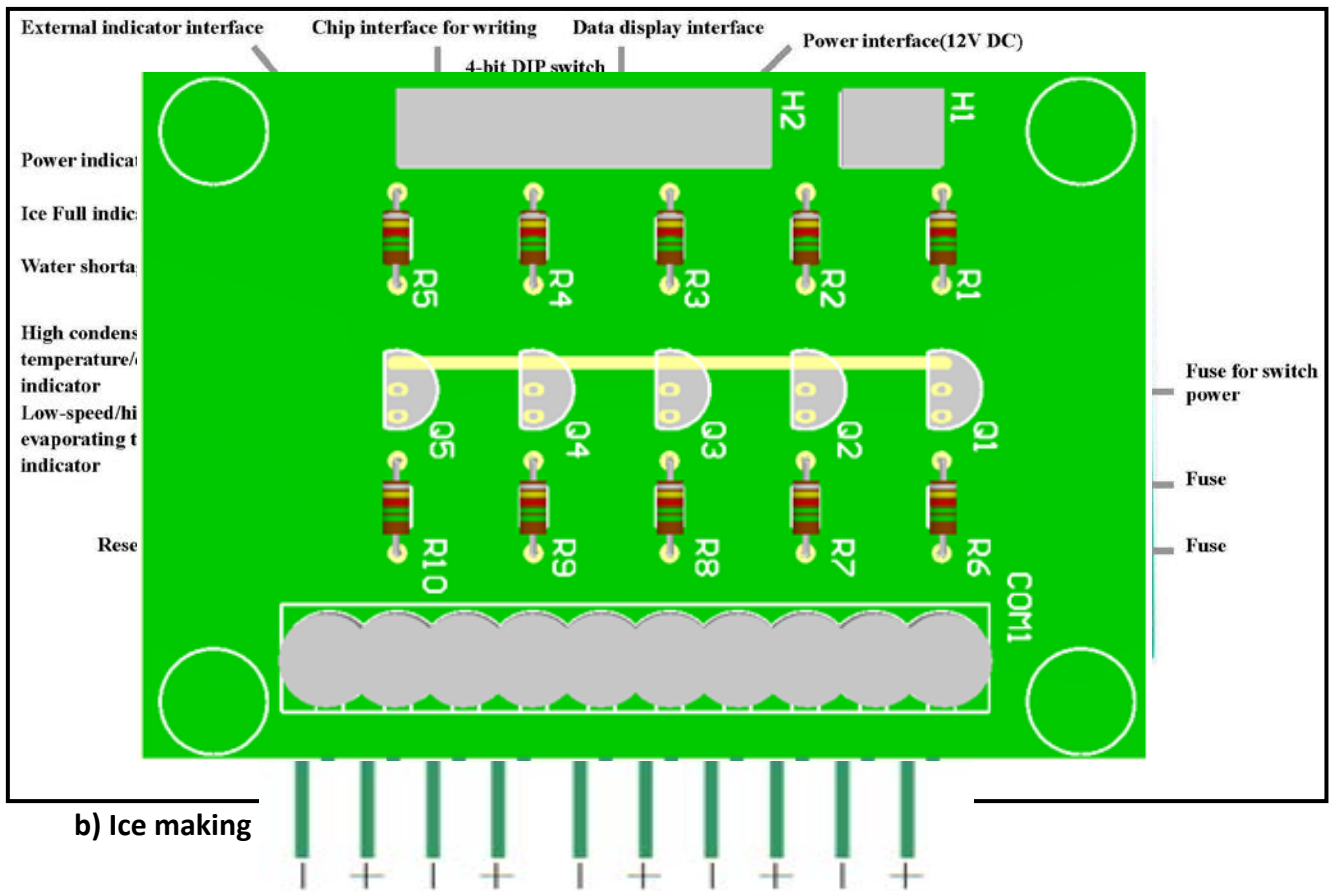

1、Ice making PC board layout (back)

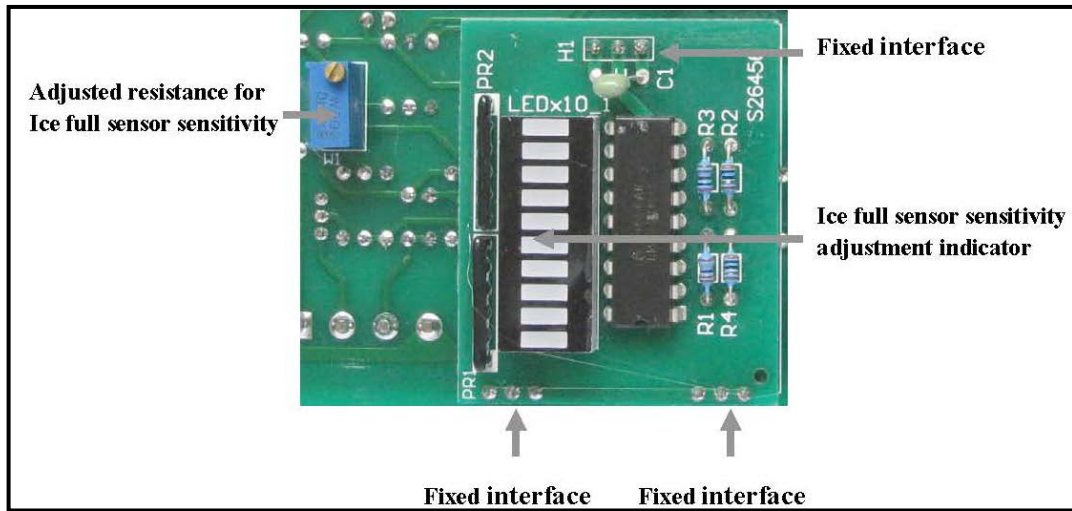

c) Ice full sensor sensitivity small board layout



2. Fault Indicator

-  Green - Power Indicator
-  Yellow - Full - ice fault indicator (Solid)
-  Yellow - Water shortage indicator (Flashing)
-  Red - Condensing temperature fault indicator (solid light) / start-up delay indicator (flashing)
-  Yellow - low-speed alarm indicator. (solid light) evaporation temperature fault indicator (flashing)

\* When the power frequency is lower than 45Hz more than five seconds all the indicator lights flash at the same time

### 3. Dip Switch

1. 8-bit DIP switch (Attention: Please press reset button before resetting DIP switch.)

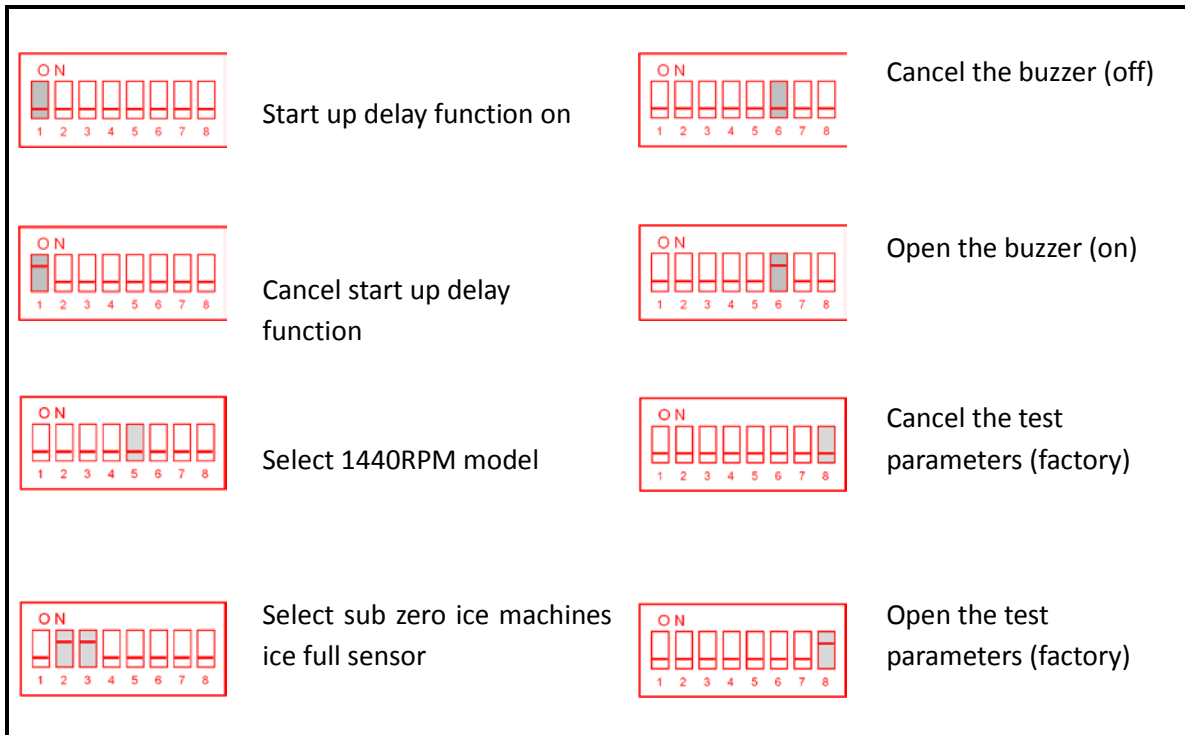

Eight-bit DIP switches on the centre of the PC board (Figure 3-1) are from left to right. Override is when dip switch is in the on position.

The function of the first bit DIP switch: Selects the starting up delay function. When the first bit DIP switch is on, the unit will start up with no delay. (This feature is used during maintenance of the ice machine). When dip switch is in the off position the unit will have a five minute delay, which is to ensure the sensor is clear of ice.

The function of the second and third bit DIP switch: Select the ice full sensor to suit ice type. To select sub zero machine ice-full sensor, both dip switch`s 2 and 3 are in the on position.

The function of the fourth bit DIP switch: DIP switch invalid.

The function of the fifth bit DIP switch: Selects the models of the gear motor.







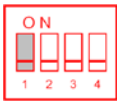

1440 RPM when the dip switch is in the off position (**the location of switch has been set up at the factory, the user should not be touched**)

**The function of the sixth bit DIP switch:** Selects the buzzer alarm. When the sixth bit DIP switch is in the on position, the buzzer will alarm when a fault is triggered, in contrast, the buzzer is silent when the dip switch is in the off position.

The function of the seventh bit DIP switch: DIP switch is invalid.

**The function of the eighth bit DIP switch:** Selects the test parameters .(testing the PC board design parameters at factory).( the switch has been set off at the factory)

b) 4-bit DIP switch (Warning: Please press reset button before resetting DIP switch.)

	Turns on the low-rotating speed fault protection		Turns on the evaporating temperature protection
	Cancels the low-rotating speed fault protection		Cancels the evaporator temperature protection
	Turns on the condensing temperature protection		Turns on the ice full protection
	Cancels the condensing temperature protection		Cancels the ice full protection

Four-bit DIP switches on the center of the PC board (Figure 3-2) are in order from left to right.

The function of the 4 dip switch's are to bypass any of the 4 sensors so the machine can continue to function until the fault is rectified. When a bypass is activated the fault light for that sensor will continue to be activated until the fault is rectified and the unit is reset.

#### 4. Electrical wiring diagram

##### a). Ice machine PC board wiring diagram

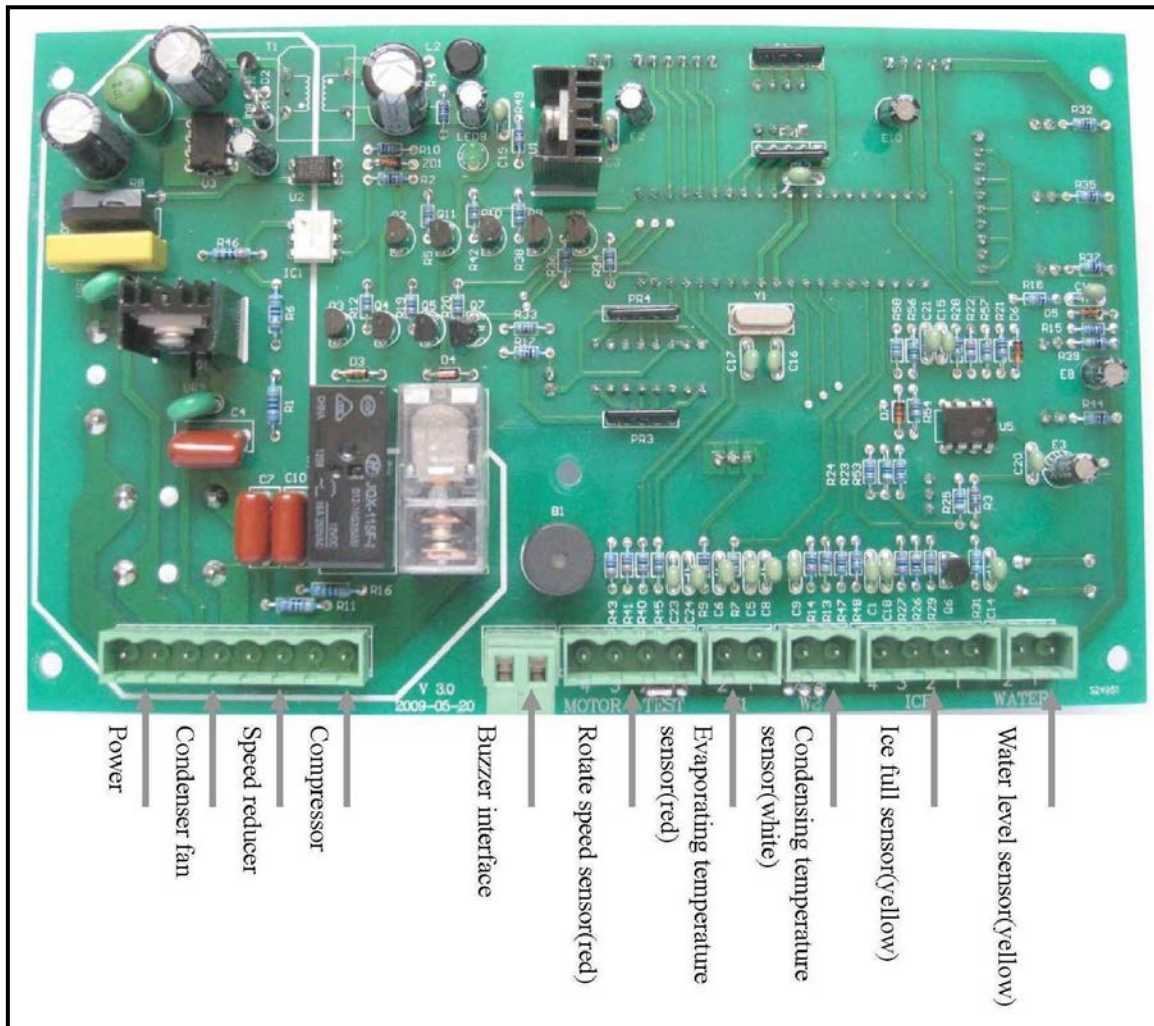

Ice making PC board layout (front) figure 4-1

b) Ice machine external indicator (small board) wiring diagram

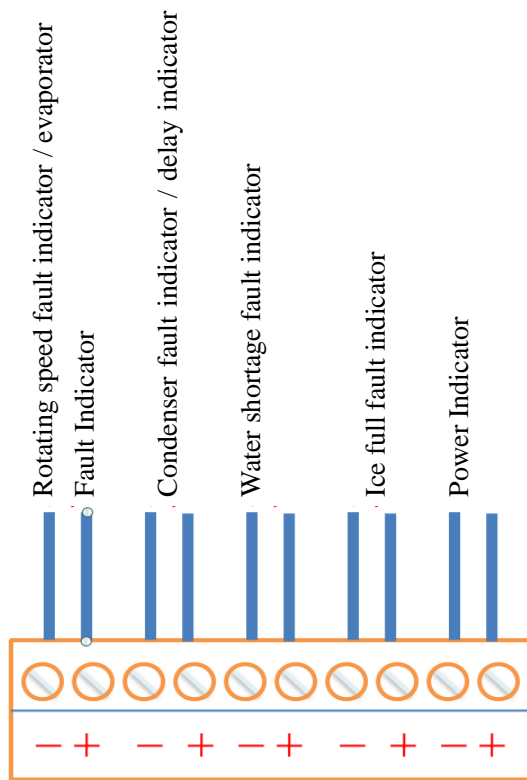

c) Ice making sensor wiring diagram

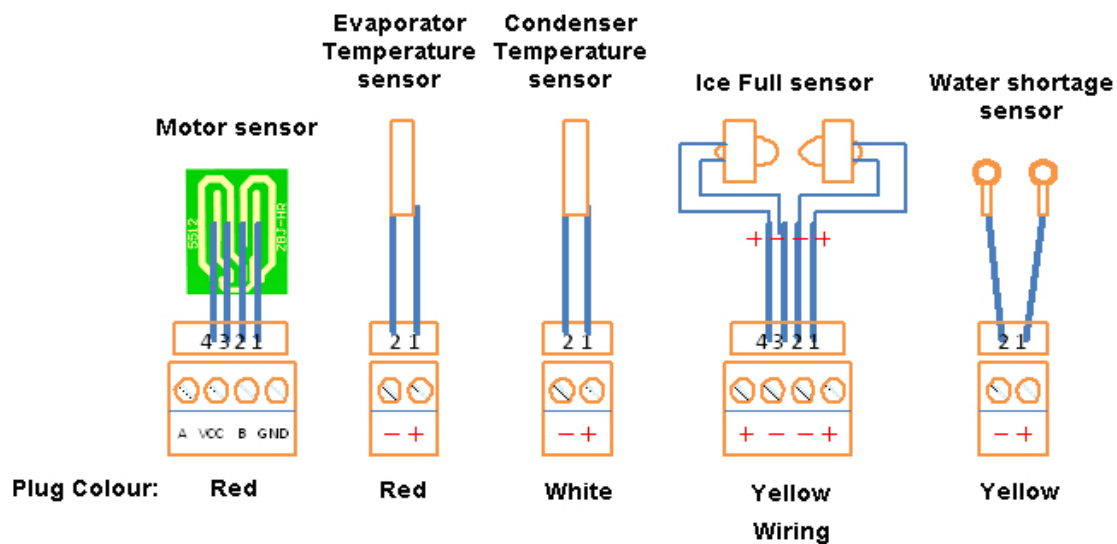

5. Ice full sensor sensitivity and DIP switch settings

a) Ice full sensor sensitivity settings

Flake ice machine: XB70—XB550 model

5 indicator.

Sub Zero machine: PB0.4F/A—PB50F/A model

5 indicator.

## b) setup of ice full sensor sensitivity

Ice full sensor sensitivity may diminish after a certain period of time. At this time, It can be adjusted by the ice full sensitivity resistor on the PC board. Clockwise rotation will increase the number of lights; ice full sensor sensitivity will increase accordingly. Anti clockwise rotation will decrease sensitivity and decrease the number of lights

The LED 1 next to the 8 dip switches is the sensitivity indicator, when the LED is lit the bin is empty, when the LED is off the bin is full.

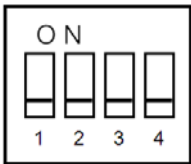

**1(ON): Cancel ice full protection.**

**2(ON): Cancel evaporation temperature protection.**

**3(ON): Cancel condensing temperature protection.**

**4(ON): Cancel low rotating speed protection.**



**1 (ON): Cancel starting up delay.**

**2,3 (ON): Select sub zero ice machine's ice-full sensor**

**4 (OFF): Not Used**

**5 (OFF): Select 1440RPM model.**

**6 (ON): Turn on the buzzer.**

**Warning: Please press reset button before resetting DIP switch**



## Grant Timer with remote switch

The Grant unit can be fitted with a remote switch and timer, the function of this is twofold.

As the electrical control board is placed on the unit, this can make access to the factory fitted switches difficult.

The remote switch allows the ON/OFF/AUTO switch to be placed in an easily accessible location, such as when the unit is placed on a large ice bin or transport system i.e. Follet ITS or DEV.

The timer is designed to reduce the ice clumping found with storing scale type ice for long periods. The theory is to supply only the ice needed for the demand, an example would be:

Grant one ton FFE on a Follett DEV. (ice bin)

Customer requires 400 kg of ice at 7am and 200kg at 4pm.

Timer will require to be set from 10pm to 7am and 11am to 4pm

Grant 1 ton FFE =  $1000\text{kg}/24\text{hrs} = 41\text{kg}/1\text{hr}$

400kg will require the unit to run for 10hours.

200kg will require the unit to run for 5hours.

Of course this is only an example and every application will vary but the principal is the same, it will be up to the technician to consult with the customer and set timer to suit their needs.

With the timer set up correctly, the machine will produce Ice on demand and prevent clumping of ice in the storage bin.

### a) Parts Identification

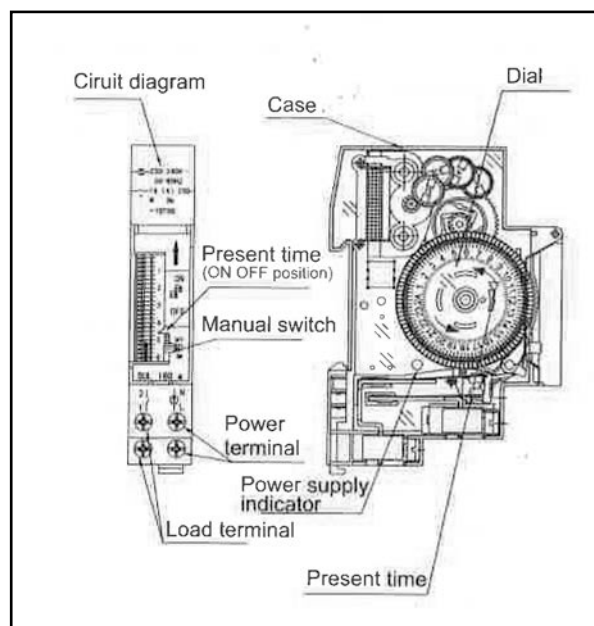

## b) Operating Instructions

Before turning power ON, Check that your unit conforms to the operating voltage.

If the unit has not been in operation for a long period the battery may have discharged and may not work immediately. Connect the unit and switch power source on, wait for approximately ten minutes before setting the timer. Full power reserve is built up after approximately 72 hours.

### 1. Setting the timer

Set the setting pin between the desired times to the left or right of the dial.

Set the setting pin to the right of the dial; ON position

If the setting pin is set to the ON position continuously, it will continue only for the number of setting pins x 15 minutes.

Set the setting pin to the right until a click is heard

Set the setting pin to the left of the dial; OFF position

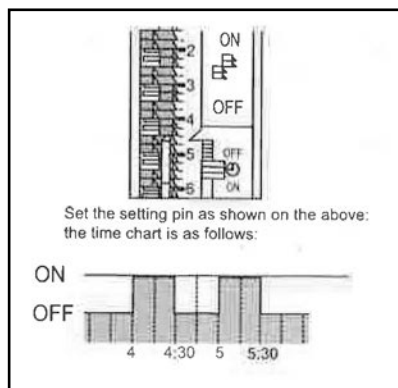

### 2. Adjust the present time

Turn the dial until the index is on the current time

### 3. Set the manual switch:

Use this switch to select either ON or OFF in manual or ON/OFF in the operation program.

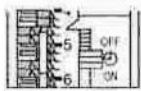

“Auto”; output is turned ON and OFF according to the set program

Manual “ON”; output is turned ON irrespective of the program (Use this mode for test operation)

Manual “OFF”; output is turned OFF irrespective of the program.

After completing test operation set the manual switch to “AUTO”

## c) Specifications

Rated Voltage		240VAC	
Voltage tolerance		220-260VAC	
Frequency		50hz	
Power consumption		1w	
Drive Method		Quartz controlled stepping motor	
Cycle		24 hours	
Time precision		+/-3 sec/ day at 22 degrees Celcius	
Load	Circuit		Separate
	Switch construction		SPST
	Manual ON/OFF		ON/AUTO/OFF switch
	Capacity	Resistive Load	16A
		Incandescent lamp	10A
Inductive		12A	
Motor		220v AC 1500W	
Setting	Present Time Setting		Turn dial until the index is at the current time
	ON/OFF program setting		15 minutes
	Minimum Unit		15 minutes
	Minimum interval		15 minutes
	No of ON/OFF operation		96 operations
Working reserve time		72 hours	
Ambient temperature		-10 degrees celcius ~ +50 degrees celcius	
Ambient humidity		Max 85%	
Weight		85g	

## **XII . Technical Notes**

1. All PC boards after November 2009 will be the bypass model which will allow all sensors to be bypassed for diagnostic purposes.
2. All Grant ice machines up to 10 ton use the same PC board.
3. All grant ice machines 10 ton and over use a PLC.
4. All the old style PC boards have no bypass on any faults except by bridging using the correct ohm resister.
5. Bin full sensor can be bypassed by bridging terminals 2 and 3.
6. All sensors can be bypassed with the correct resister.
7. Low temp sensor can be bypassed with a 10 ohm resister.
8. High condenser temp sensor can be bypassed with a 91 ohm resister.
9. Gear motor speed sensor cannot be bypassed.
10. The square blue potentiometer on the PC board is to set/adjust the sensitivity of the bin full sensor. A correct setting is 5 lights on the small circuit card on the front of the board. If the sensitivity is set to high the sensor can burn out.
11. Speed sensor operates at 1440rpm with a 7% differential.
12. Speed of the gearbox is governed by the hertz and should be checked on every installation.
13. Hertz under 45 will cause low rotation fault.
14. Phase fail control requires a voltage of not less than 380 or greater than 450 volts, but can be set at 10% lower to get out of trouble but is not recommended.
15. Scraper must always be set at 0.3mm off evaporator shell, use a set of feeler gauges.
16. Incorrect ice thickness will trip speed sensor and cause shuddering.
17. If gearbox / scrapper shuddering occur water flow is too great and should be reduced and or TX valve may need adjusting.
18. TX feed can be checked by ice formation on evaporator, i.e. ice forming lines in evaporator increase TX feed.
19. The core dryer fitted to the suction line has no core fitted; the dryer is there for quality control at the factory and is removed after testing.

## **XIII. Service Bulletins**

### **Coast tip of the week:**

#### **Blocked water filter bypass**

If you need to bypass the water filter in an emergency you can carry out the following to get you out of trouble until you can replace the cartridge.

1. Isolate water to filter
2. Remove filter cartridge
3. Remove small O ring
4. Re-install filter cartridge
5. Turn water back on

By caring out the above, this bypasses the cartridge and allows water to flow to your machine.

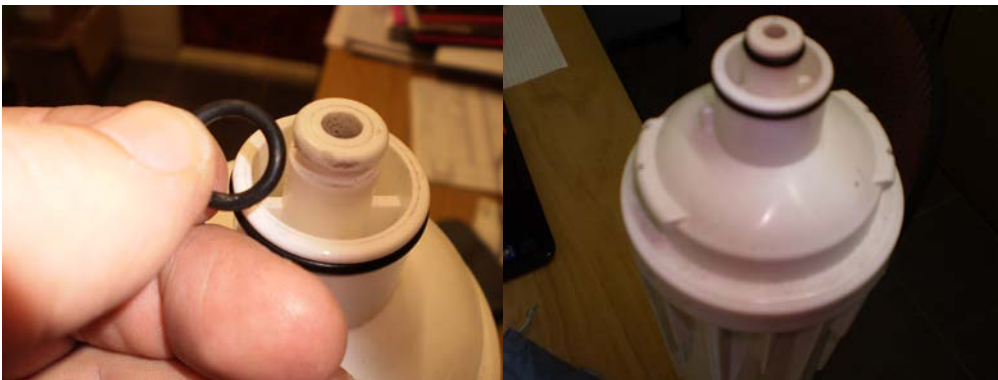

**NOTE:** return and replace the filter cartridge as soon as possible

## Water regulating valve

If there is water dripping or flowing into the bin from under the evaporator, check the water flow over the evaporator.



**Ball float adjustment under**      **Water flow regulator valve**

To adjust the water flow so as not to overflow the drain catchment tray, adjust this valve slowly to regulate the water flow. If the flow is too high, the water overflows the drain tray. If the flow is insufficient there will be little ice production.

## Service & Maintenance Scedule

	JAN	FEB	MAR	APR	MAY	JUN
Date						
Water Cartridge changed						
Chemically Cleaned						
Sanitized						
Condensor cleaned						
Operation checked						
Technicians name						
	JUL	AUG	SEPT	OCT	NOV	DEC
Date						
Water cartridge changed						
Chemically cleaned						
Sanitized						
Condensor cleaned						
Operation checked						
Technicians name						

**1800 688 590**

Ph: **02 9524 1234**

Fax: **02 9524 0968**

Email: **[sales@coastdistributors.com.au](mailto:sales@coastdistributors.com.au)**

Web: **[www.coastdistributors.com.au](http://www.coastdistributors.com.au)**

**COAST**  
**DISTRIBUTORS PTY LTD**